



# INDUSTRIES LIMITED

	Model	Size	Pressure Vessel Volume	Max Pressure
<input type="checkbox"/>	CBF-2	3/4"	2 gal (7.6L)	265psi (1.83MPa)
<input type="checkbox"/>	CBF-5	3/4"	5 gal (18.9L)	265psi (1.83MPa)

## SPECIFICATION

Chemical By-Pass Feeder shall be AXIOM INDUSTRIES LTD. model CBF-\_\_\_\_\_. System shall include carbon steel chemical by-pass feeder, two 3/4" NPT carbon steel tees, four 3/4" NPT carbon steel nipples, two 3/4" NPT brass ball valves, 1/4" NPT brass ball valve, and 20 US oz.(600 mL) polyethylene graduated funnel with integral 20 mesh strainer, and 3/4" NPT connection. The CBF series pot feeder is not for use with potable water. Model CBF-5 series comes with three 17.6" (44.7cm) long adjustable steel legs.

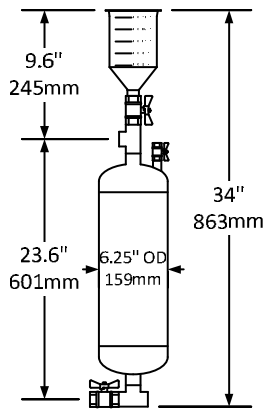

**CBF-2**

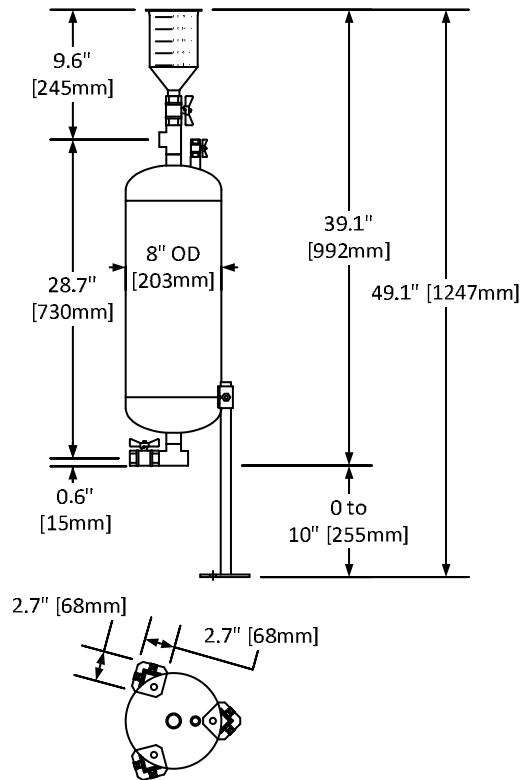

**CBF-5**

## ACCESSORIES

- CBF-B** – Wall mount Bracket for the CBF-2

## LIMITED WARRANTY

The Axiom CBF Chemical By-Pass Feeder is warranted against defects in materials and workmanship for one year.

Project \_\_\_\_\_

Location \_\_\_\_\_

Consultant \_\_\_\_\_

Contractor \_\_\_\_\_

Unit Tag \_\_\_\_\_

Sales Agent \_\_\_\_\_