

PEX Tubing Organizer



PEX-Pal™



PEX-Jr

Ideal for over-pour radiant floor heating

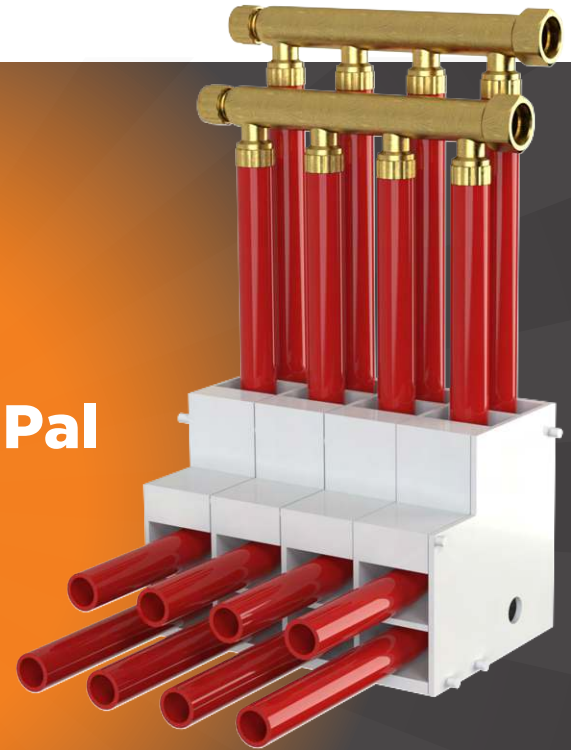

PEX-Pal

Ideal for in-floor high mass radiant floor heating

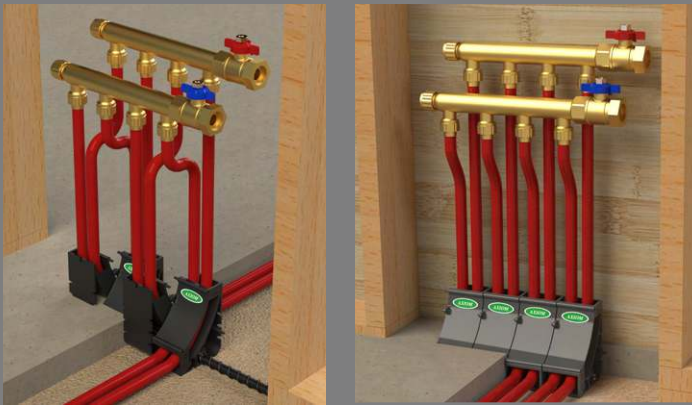

3.2 inch

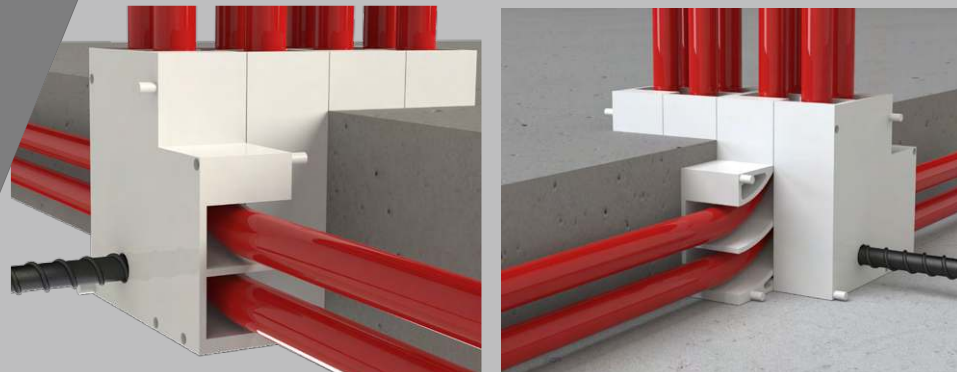

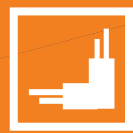

PEX-Pal Jr

Tubing Bracket and Organizer

For over-pour radiant installations.



PEX-Jr



- Organizes & Protects tubing at the poured floor surface
- Ideal for over-pour applications
- Multiple modules press-fit together to match the number of loops on the manifold
- Each module fits supply & return tube
- Outlets can be reversed for manifold locations with piping in opposite directions
- Constructed of co-polymer polypropylene
- Designed to maintain manufacturers' recommended minimum bend radius
- Enclosed side
- Fits inside 2x4 interior wall

PEX-Pal

Tubing Bracket and Organizer

For high-mass radiant installations.

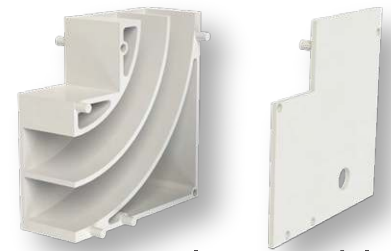
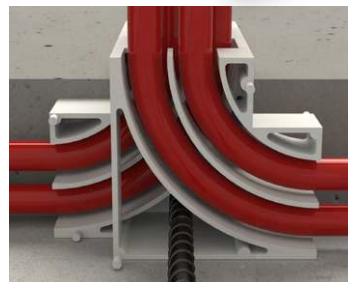
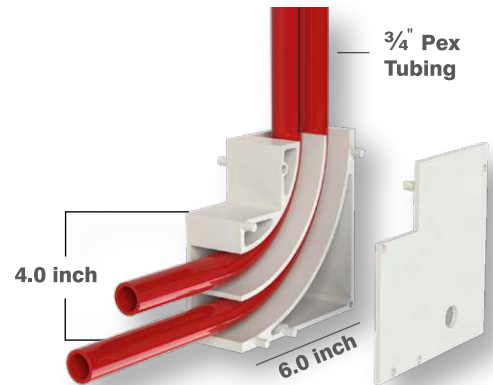

PEX-Pal

EndPlate

- Organizes & Protects tubing at the poured floor surface
- Ideal for high-mass radiant heating applications
- Multiple modules press-fit together to match the number of loops on the manifold
- Each module fits supply & return tube
- Outlets can be reversed for manifold locations with piping in opposite directions
- Constructed of high impact polystyrene
- Designed to maintain manufacturers' recommended minimum bend radius
- For use on slabs upto 6" depth

Product	Application	Tubing Size	Box Qty
PEX-Jr	Over-pour application	Up to 1/2"	12
PEX-Pal	High-mass radiant	Up to 3/4"	40
EndPlate	EndPlate for PEX-Pal <small>* Not Required for the PEX-Jr</small>	—	10